

E-Series

In-picture audio meter and alarm system

From the range of in-picture audio meters by Chromatec

User instructions



DISTRIBUTED WORLDWIDE:
MICHAEL STEVENS & PARTNERS LTD
INVICTA WORKS ELLIOTT ROAD BROMLEY KENT BR2 9NT UK
TEL: +44 (0)20 8460 7299 FAX: +44 (0)20 8460 0499
E-MAIL: SALES@MICHAEL-STEVENSON.COM
WEB: [HTTP://WWW.CHROMATEC.COM](http://www.chromatec.com)

Michael Stevens & Partners Ltd. has made every effort to ensure the accuracy of information contained within this document which is nevertheless supplied for information purposes only and does not constitute any form of warranty or guarantee.

All trademarks acknowledged.

The information in this document is subject to change without notice.

Michael Stevens & Partners Ltd
Invicta Works
Elliott Road
Bromley
Kent
BR2 9NT
Tel: +44 (0)20 8460 7299
Fax: +44 (0)20 8460 0499
Email: sales@michael-stevens.com
web site: www.michael-stevens.com www.chromatec.com

Contents

INTRODUCTION	1
<i>Main features</i>	1
OPERATION	3
THE NORMAL DISPLAY	3
FRAME ALARM STATUS	3
NAVIGATING THE DISPLAY	4
MENU COMMANDS	5
<i>Parameter lists</i>	5
<i>Selecting a sub-menu</i>	6
<i>Main Menu pages</i>	7
<i>Alarms menu pages</i>	9
<i>Alarms status menu pages</i>	11
<i>Colours menu pages</i>	12
<i>Bargraph Variations</i>	13
INSTALLATION	14
FITTING CHROMATEC E-SERIES CARDS	14
<i>Identifying cards</i>	15
CHOOSING THE VIDEO OUTPUT	15
LINKING FRAMES	16
SELECTING THE FRAME ADDRESS	16
HEALTH AND SAFETY CONSIDERATIONS	17
<i>Disposal</i>	17
CONNECTOR I/O	18
<i>Audio input connector pinout</i>	18
<i>Alarms connector pinout</i>	19
<i>RS422 Link in/out connectors pinout</i>	19
<i>RS232 Host interface connector pinout</i>	20
PROBLEM SOLVING	21
<i>Sample problems and their solutions</i>	22
SPECIFICATION	23

Introduction

The Chromatec E-Series is a multi-channel in-picture audio meter and alarm system. It enables any number of two or four channel bargraphs to be displayed in colour on multiples of SDI or composite video monitors.

Alarms can be generated for a range of video and audio failure conditions and presented as in-picture alerts, audible buzzers or external alarms via a serial port or TTL outputs.

The modular E-Series is available as either a 3U or 1U rack mounting frame. The 3U frame can take 16 Eurocard modules, whilst the 1U frame can take 6 modules. This manual deals with the use of E-Series modules in the 3U frame.

Main features

- Multi-channel, multi-monitor in-picture audio meter and alarm system
- Optional Windows™ software for control, alarm monitoring to 16 cards, scheduling & data logging
- Eurocard system, one 3U frame containing up to 16 cards
- Up to 32 frames may be linked and controlled from any point
- Control module with LCD menu for configuring system
- Cards may be addressed individually or collectively
- Four types of card to support SDI in, SDI or composite out or composite only in/out video formats as well as four channels of analogue audio, AES/EBU digital audio or embedded SDI formats
- Cards may be mixed format in any frame
- Superimposed (mixed) colour bargraphs may be full, half or quarter height with peak-hold and out of phase indicators
- Six standard meter scales and ballistics with sum only or sum and difference (M&S)
- RS-232 host interface for automation control (protocol available)
- Each module has assignable alarms according to the chosen format, SDI loss, SDI freeze, picture loss, sync loss, AES/EBU loss, audio loss, audio over and sustained anti-phase
- In-picture alarm status indicators, buzzer and flashing bargraph

Each 3U E-Series frame is supplied with one control module and an integral PSU. A 1U E-Series external auxiliary PSU is available (Chromatec Model E-PSU) if redundant power is required.

The available E-Series modules are as follows:

Part number	Description
SD4-EA	SDI video in, analogue or embedded audio in, serial number prefix SDA
SD4-ED	SDI video in, AES or embedded audio in, serial number prefix SDD
AM4-EA	Composite video in, analogue audio in, serial number prefix AB
AM4-ED	Composite video in, AES audio in, serial number prefix DB

Note: Each card may be identified by a label attached to the handle or by the serial number printed on the rear of the module



The E-Series bargraph (full size AES/EBU scale) mixed against video background

Operation

The front panel user interface consists of 6 buttons and a LCD panel interface.



The E-Series 3U rack front control panel

The normal display

In the absence of an active assigned alarm, the LCD panel will display 'Chromatec 'E' Series'. If an alarm is assigned and active, then a graphic will be shown depicting the eight alarms for all sixteen cards in the frame that triggered the alarm.

Frame alarm status

In an alarm condition, the Frame Alarms Status page of the LCD opens automatically on the relevant frame, replacing the normal display. This is a graphic representing all 16 cards in the frame and a flashing indicator against the alarm assignment (1 to 8) that has been triggered. In addition the ALM LED next to the buttons will illuminate.

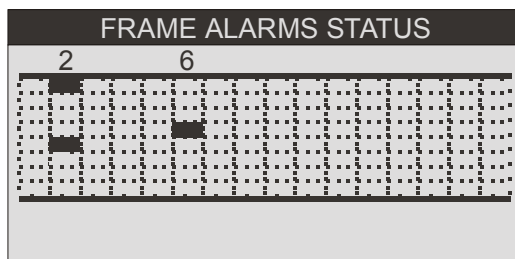



The Frame alarms status display



The normal display

Navigating the display

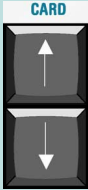
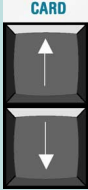
The 6 menu buttons are used to call up LCD menus and have the following functions:

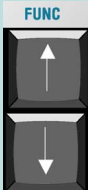
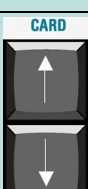
Button		Descriptions
Unlock (hold both CARD buttons down together)		In normal use the configuration menu will be locked to prevent inadvertent operation. To unlock the system hold the left hand pair of up and down arrows down for about three seconds to enter the select-menu mode.
Card select		Once any sub-menu is displayed the left hand pair of up/down arrows are used to select an individual card in a frame or all modules in a frame (FRM) and all cards in a system (ALL).
Value		Use these buttons to select the highlighted menu or parameter value in a sub-menu. Both Value buttons pressed together simultaneously act as confirmation in some of the menus.
Function (press both buttons together to enter/leave sub-menu)		Press both Function up/down arrow buttons to enter or leave sub-menus. Once in a sub-menu, the Function buttons can be used to select the appropriate parameter to control. Pressing both Function buttons in normal mode also mutes any active internal buzzer.
Lock/Save (press both buttons together)		To exit all menus and save settings press both Card buttons simultaneously. If there are no alarms active the normal display will be displayed. If there are active alarms, the LCD will show Frame Alarms Status.

Button functions

Note: The LED alarm indicator adjacent to the Lock button indicates alarm condition and an internal buzzer may optionally sound. Pressing both Function buttons (in the normal operating mode) mutes the buzzer on that frame and the Mute LED lights.
If the Frame Status grid is displayed, press any Function button to scroll through the alarms.

Menu Commands

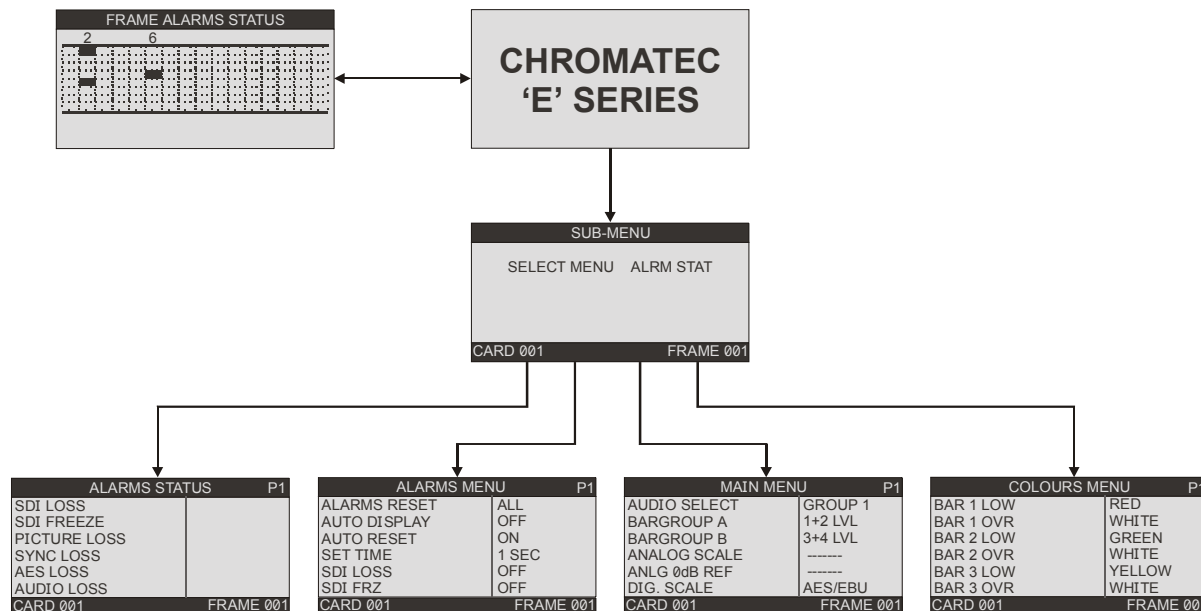

Menu Structure – only top sub-menu pages shown

Parameter lists

In the following menus, parameters are shown in square brackets. For example the available analogue or digital scales are shown as a list:

[BBC] [DIN] [VU] [EXTD VU] [NORDIC]

The middle 'Value' buttons will cycle through the parameter list one by one. Where a parameter list contains dependent or sub parameters, these values appear after the major parameter. For example Audio Loss can have six sub-parameters:

[AUD LOSS]>[CHAN 1+2>CHAN 3+4>CHAN1>CHAN2>CHAN3>CHAN4]

The chevron > in the text shows the dependent relationship. The parameters in the LCD display do NOT have the chevron in the display.

Note: Dashes will be shown if a parameter is not supported by an individual card selected. If the ALARMS, MAIN or COLOURS sub-menus are visited, the cursor is normally returned to the same point in the menu that was visited last. This helps to reduce the number of button presses required to configure common functions.

Selecting a sub-menu

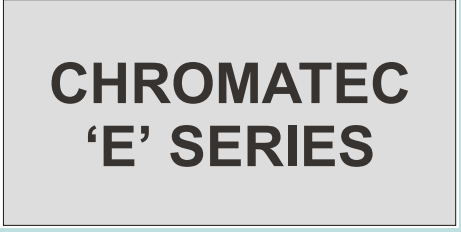
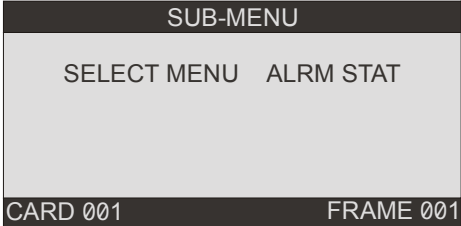
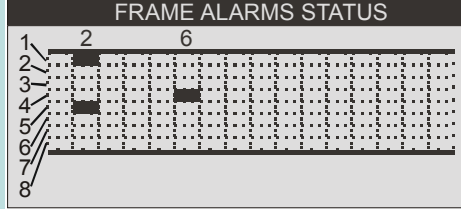
The 'Normal' or 'Locked' Display	Description
	<p>Normal or 'Locked' mode display with no alarms.</p> <p>From 'Lock' press both Card buttons simultaneously for three seconds to enter Select Menu mode.</p>
Select Menu	Description
 <p>Cycle through available menus with left or right Value buttons.</p> <p>Press both Function buttons to enter or leave a chosen menu.</p>	<p>Available menus from Select Menu mode:</p> <ul style="list-style-type: none"> [Main Menu] [Alarms Status] [Alarms Menu] [Colours Menu]
Frame Alarms Display	Description
	<p>In an alarm condition, the Frame Alarms Status page of the LCD opens automatically on the relevant frame. This replaces the 'Normal' or 'Locked' display</p> <p>This is a graphic representing all 16 cards in the frame and a flashing indicator against the alarm assignment (1 to 8) that has been triggered. The rows on the Frame Alarms Status graphic correspond from top to bottom with assigned alarms 1 to 8. The row numbers in the illustration are not shown on the LCD.</p> <p>Press any button to go straight to the Alarms Menu.</p>

Main Menu pages

Main Menu page 1	Description																					
<table border="1"> <thead> <tr> <th colspan="2">MAIN MENU</th> <th>P1</th> </tr> </thead> <tbody> <tr> <td>AUDIO SELECT</td> <td>GROUP 1</td> <td></td> </tr> <tr> <td>BARGROUP A</td> <td>1+2 LVL</td> <td></td> </tr> <tr> <td>BARGROUP B</td> <td>3+4 LVL</td> <td></td> </tr> <tr> <td>ANLG 0dB REF</td> <td>-----</td> <td></td> </tr> <tr> <td>DIG. SCALE</td> <td>AES/EBU</td> <td></td> </tr> <tr> <td>CARD 001</td> <td>FRAME 001</td> <td></td> </tr> </tbody> </table> <p>Cycle through functions with up or down Function buttons. Scroll down to access further pages of functions.</p> <p>Value buttons assign function parameter.</p>	MAIN MENU		P1	AUDIO SELECT	GROUP 1		BARGROUP A	1+2 LVL		BARGROUP B	3+4 LVL		ANLG 0dB REF	-----		DIG. SCALE	AES/EBU		CARD 001	FRAME 001		<p>Audio Select [SDI GRP1] [SDI GRP2] [SDI GRP3] [SDI GRP4] [EXTERNAL] Determines which embedded audio group or external audio (analogue or AES/EBU) is displayed and assigns alarm functions to that group when activated.</p> <p>Bargroup A [OFF] [1+2 LVL] [3+4 LVL] [1+2 S+D] [1+2 SUM] [3+4 S+D] [3+4 SUM] Selects the channels to be displayed and whether to display them in level, sum or sum and difference modes.</p> <p>Bargroup B as above</p> <p>Analogue Scale [BBC] [DIN] [VU] [EXTD VU] [NORDIC] Selects between standard analogue scales and ballistics.</p> <p>Analogue 0dB Reference [-10dB] to [+12dB] in 1dB steps Selects the analogue input level reference to 0dB.</p> <p>Digital Scale [BBC] [DIN] [VU] [EXTD VU] [NORDIC] [AES/EBU] Selects either the standard AES/EBU digital scale and ballistics or various analogue scales and ballistics.</p>
MAIN MENU		P1																				
AUDIO SELECT	GROUP 1																					
BARGROUP A	1+2 LVL																					
BARGROUP B	3+4 LVL																					
ANLG 0dB REF	-----																					
DIG. SCALE	AES/EBU																					
CARD 001	FRAME 001																					

Main Menu page 2	Description																								
<table border="1"> <thead> <tr> <th colspan="2">MAIN MENU</th> <th>P2</th> </tr> </thead> <tbody> <tr> <td>A-D 0dB REF</td> <td>-18dB</td> <td></td> </tr> <tr> <td>COLOUR CHG A</td> <td>0dB</td> <td></td> </tr> <tr> <td>COLOUR CHG D</td> <td>-18dB</td> <td></td> </tr> <tr> <td>BAR HEIGHT</td> <td>FULL</td> <td></td> </tr> <tr> <td>H POSITION</td> <td>13</td> <td></td> </tr> <tr> <td>V POSITION</td> <td>38</td> <td></td> </tr> <tr> <td>CARD 001</td> <td>FRAME 001</td> <td></td> </tr> </tbody> </table> <p>Cycle through functions with up or down Function buttons.</p> <p>Scroll up or down to access other pages of functions.</p> <p>Value buttons assign function parameter.</p>	MAIN MENU		P2	A-D 0dB REF	-18dB		COLOUR CHG A	0dB		COLOUR CHG D	-18dB		BAR HEIGHT	FULL		H POSITION	13		V POSITION	38		CARD 001	FRAME 001		<p>Analogue to Digital 0dB Reference [-10dB] to [-30dB] in 1dB steps When using analogue scales on digital feed, sets the analogue to digital 0dB reference level.</p> <p>Colour Change A [-10dB] to [10dB] in 1dB steps Sets the colour transition point of each analogue bargraph.</p> <p>Colour Change D [0dB] to [-30dB] in 1dB steps Sets the colour transition point of each digital bargraph.</p> <p>Bar Height [QTR] [HALF] [FULL] Selects the bar group size.</p> <p>Horizontal Position [0] to [179] Adjusts the precise horizontal position of the bar group, with the maximum value depending on the block horizontal size. Every increment corresponds to 4 screen pixels.</p> <p>Vertical Position [0] to [255] Adjusts the precise vertical position of the bar group, with the maximum value depending on the block vertical size. Every increment corresponds to 2 screen lines.</p>
MAIN MENU		P2																							
A-D 0dB REF	-18dB																								
COLOUR CHG A	0dB																								
COLOUR CHG D	-18dB																								
BAR HEIGHT	FULL																								
H POSITION	13																								
V POSITION	38																								
CARD 001	FRAME 001																								

Note: Input sensitivity adjustment and 0dB references apply to all channels on each card.

Main Menu page 3	Description																								
<table border="1"> <thead> <tr> <th colspan="2">MAIN MENU</th> <th>P3</th> </tr> </thead> <tbody> <tr> <td>FADE LEVEL</td> <td>20</td> <td></td> </tr> <tr> <td>PHASE IND</td> <td>ON</td> <td></td> </tr> <tr> <td>PEAK-HOLD</td> <td>1 SEC</td> <td></td> </tr> <tr> <td>BAR WIDTH</td> <td>12</td> <td></td> </tr> <tr> <td>VIDEO BYPASS</td> <td>OFF</td> <td></td> </tr> <tr> <td>VIDEO MODE</td> <td>AUTO</td> <td></td> </tr> <tr> <td>CARD 001</td> <td></td> <td>FRAME 001</td> </tr> </tbody> </table> <p>Cycle through functions with up or down Function buttons.</p> <p>Scroll up or down to access other pages of functions.</p> <p>Value buttons assign function parameter.</p>	MAIN MENU		P3	FADE LEVEL	20		PHASE IND	ON		PEAK-HOLD	1 SEC		BAR WIDTH	12		VIDEO BYPASS	OFF		VIDEO MODE	AUTO		CARD 001		FRAME 001	<p>Fade Level [0] to [32] Adjusts the fade level of the bar group in relation to the video background.</p> <p>Phase Indicator [ON] [OFF] Out-of-phase indicator located at top of bargraphs is activated.</p> <p>Peak-Hold [OFF] 1, 2, 3, 4, 5, 10 seconds [INFINITE] Sets the decay time of the peak-hold cursor at the tops of the bargraphs.</p> <p>Bar Widths [8] to [22] in 2 pixel steps (value is shown in pixels) Sets all bar widths.</p> <p>Video Bypass [OFF] [ON] Incoming video is switched directly to the video output of the card, bypassing the bargraph generator.</p> <p>Video Mode [AUTO] [INTERNAL] [EXTERNAL] AUTO displays the bargraph on external video, reverting to internal black if the external video is lost. INTERNAL displays the bargraph on internal black only. EXTERNAL displays the bargraph only in the presence of external video.</p>
MAIN MENU		P3																							
FADE LEVEL	20																								
PHASE IND	ON																								
PEAK-HOLD	1 SEC																								
BAR WIDTH	12																								
VIDEO BYPASS	OFF																								
VIDEO MODE	AUTO																								
CARD 001		FRAME 001																							

Main Menu page 4	Description																		
<table border="1"> <thead> <tr> <th colspan="2">MAIN MENU</th> <th>P4</th> </tr> </thead> <tbody> <tr> <td>INTERNAL VID</td> <td>PAL</td> <td></td> </tr> <tr> <td>NTSC PED</td> <td>ON</td> <td></td> </tr> <tr> <td>SET DEFAULTS</td> <td></td> <td></td> </tr> <tr> <td>UNIT ADDRESS</td> <td>1</td> <td></td> </tr> <tr> <td>CARD 001</td> <td></td> <td>FRAME 001</td> </tr> </tbody> </table> <p>Cycle through functions with up or down Function buttons.</p> <p>Scroll up to access previous pages of functions.</p> <p>Value buttons assign function parameter. When pressed together Value buttons act as confirmation of Set Defaults and Unit Address selection.</p>	MAIN MENU		P4	INTERNAL VID	PAL		NTSC PED	ON		SET DEFAULTS			UNIT ADDRESS	1		CARD 001		FRAME 001	<p>Internal Video [PAL] [NTSC] Selects the video standard when the Video Mode is set to INTERNAL.</p> <p>NTSC Pedestal [ON] [OFF] NTSC Video Pedestal.</p> <p>Set Defaults Restores the card, frame or system to defaults. Confirm Set Defaults by pressing both middle left/right (Value) buttons simultaneously.</p> <p>Unit Address [0] to [31] Assigns an address to the frame. The address must be unique to avoid conflicts on the serial bus. Confirm the address choice by pressing both middle left/right (Value) buttons simultaneously.</p>
MAIN MENU		P4																	
INTERNAL VID	PAL																		
NTSC PED	ON																		
SET DEFAULTS																			
UNIT ADDRESS	1																		
CARD 001		FRAME 001																	

Alarms menu pages

Alarms Menu page 1	Description																								
<table border="1"> <thead> <tr> <th colspan="2">ALARMS MENU</th> <th>P1</th> </tr> </thead> <tbody> <tr> <td>ALARMS RESET</td> <td>ALL</td> <td></td> </tr> <tr> <td>AUTO DISPLAY</td> <td>OFF</td> <td></td> </tr> <tr> <td>AUTO RESET</td> <td>ON</td> <td></td> </tr> <tr> <td>SET TIME</td> <td>1 SEC</td> <td></td> </tr> <tr> <td>SDI LOSS</td> <td>OFF</td> <td></td> </tr> <tr> <td>SDI FRZ</td> <td>OFF</td> <td></td> </tr> <tr> <td>CARD 001</td> <td></td> <td>FRAME 001</td> </tr> </tbody> </table> <p>Cycle through functions with up or down Function buttons. Scroll down to access further pages of functions.</p> <p>Value buttons assign function parameter. When pressed together Value buttons act as confirmation of Alarms Reset.</p>	ALARMS MENU		P1	ALARMS RESET	ALL		AUTO DISPLAY	OFF		AUTO RESET	ON		SET TIME	1 SEC		SDI LOSS	OFF		SDI FRZ	OFF		CARD 001		FRAME 001	<p>Alarms Reset [ALL] [SDI LOSS] [SDI FRZ] [PIC LOSS] [SYNC LOSS] [AES LOSS] [AUD LOSS] [AUD OVER] [PHASE] Reset is performed by pressing both middle left/right (Value) buttons simultaneously. The ALARM RESET line of the menu will flash on/off briefly to indicate that the reset function has been performed.</p> <p>Auto Display [OFF] [ON] When off, the bargraphs are normally hidden. In an alarm condition they are displayed.</p> <p>Auto Reset [ON] [OFF] All alarms activated will automatically be reset after a predetermined time set below.</p> <p>Set Time 1, 5, 10, 30 seconds, 1, 5, 10, 30 minutes, 1...12 hours</p> <p>SDI Loss [ON] [OFF] If the SDI feed is lost, the SDI alarm is activated. The corresponding card then defaults to internal black.</p> <p>SDI Freeze [OFF] 1, 3, 5, 10, 30, 60 seconds If the SDI picture does not change for the predetermined period, the SDI Freeze alarm is activated.</p>
ALARMS MENU		P1																							
ALARMS RESET	ALL																								
AUTO DISPLAY	OFF																								
AUTO RESET	ON																								
SET TIME	1 SEC																								
SDI LOSS	OFF																								
SDI FRZ	OFF																								
CARD 001		FRAME 001																							

Note: An activated alarm automatically resets after the alarm condition disappears for a predetermined time as set in the Auto Reset function. If the alarm condition reappears before the alarm has been reset, then the Auto Reset countdown will be cancelled and will not restart again until the alarm condition disappears.

Alarms Menu page 2	Description																								
<table border="1"> <thead> <tr> <th colspan="2">ALARMS MENU</th> <th>P2</th> </tr> </thead> <tbody> <tr> <td>PICTURE LOSS</td> <td>OFF</td> <td></td> </tr> <tr> <td>SYNC LOSS</td> <td>-----</td> <td></td> </tr> <tr> <td>AES LOSS</td> <td>OFF</td> <td></td> </tr> <tr> <td>AUDIO LOSS</td> <td>OFF</td> <td></td> </tr> <tr> <td>SET TIME</td> <td>10 SECS</td> <td></td> </tr> <tr> <td>SET A LEVEL</td> <td>-----</td> <td></td> </tr> <tr> <td>CARD 001</td> <td></td> <td>FRAME 001</td> </tr> </tbody> </table> <p>Cycle through functions with up or down Function buttons.</p> <p>Scroll up or down to access other pages of functions.</p> <p>Value buttons assign function parameter.</p>	ALARMS MENU		P2	PICTURE LOSS	OFF		SYNC LOSS	-----		AES LOSS	OFF		AUDIO LOSS	OFF		SET TIME	10 SECS		SET A LEVEL	-----		CARD 001		FRAME 001	<p>Picture Loss [OFF] 1, 3, 5, 10, 30, 60 seconds If SDI video is present but the picture luminance value remains at a low level for the set time, the Picture Loss alarm is activated. (Not available with composite input cards)</p> <p>Sync Loss [OFF] [ON] If video sync is lost, the Sync Loss alarm is activated. The corresponding card then defaults to black.</p> <p>AES Loss [OFF] [CHAN 1+2] [CHAN 3+4] [ALL CHAN] If the AES/EBU feed is lost, the AES loss alarm is activated.</p> <p>Audio Loss [OFF] [CHAN 1+2] [CHAN 3+4] [ALL CHAN] Selecting relevant channels activates the audio loss alarm according to the parameters set on the three following pages.</p> <p>Set Time 5, 10, 20, 30, 40, 50, 60 seconds The time period before the audio loss alarm is activated.</p> <p>Set A Level [-40dB] [-30dB] [-20dB] [-10dB] [0dB] The threshold level of the analogue audio loss alarm.</p>
ALARMS MENU		P2																							
PICTURE LOSS	OFF																								
SYNC LOSS	-----																								
AES LOSS	OFF																								
AUDIO LOSS	OFF																								
SET TIME	10 SECS																								
SET A LEVEL	-----																								
CARD 001		FRAME 001																							

Alarms Menu page 3	Description																								
<table border="1" style="width: 100%; border-collapse: collapse;"> <thead> <tr> <th colspan="2" style="background-color: #333; color: white;">ALARMS MENU</th> <th style="background-color: #333; color: white;">P3</th> </tr> </thead> <tbody> <tr> <td>SET D LEVEL</td> <td>-20dB</td> <td></td> </tr> <tr> <td>AUDIO OVER</td> <td>OFF</td> <td></td> </tr> <tr> <td>SET A LEVEL</td> <td>-----</td> <td></td> </tr> <tr> <td>SET D LEVEL</td> <td>-20dB</td> <td></td> </tr> <tr> <td>ANTI-PHASE</td> <td>OFF</td> <td></td> </tr> <tr> <td>SET TIME</td> <td>1 SEC</td> <td></td> </tr> <tr> <td style="background-color: #333; color: white;">CARD 001</td> <td style="background-color: #333; color: white;">FRAME 001</td> <td></td> </tr> </tbody> </table> <p>Cycle through functions with up or down Function buttons.</p> <p>Scroll up to access previous pages of functions, or down to reach assignable alarms.</p> <p>Value buttons assign function parameter.</p>	ALARMS MENU		P3	SET D LEVEL	-20dB		AUDIO OVER	OFF		SET A LEVEL	-----		SET D LEVEL	-20dB		ANTI-PHASE	OFF		SET TIME	1 SEC		CARD 001	FRAME 001		<p>Set D Level [-20dB] [-30dB] [-40dB] [-50dB] The threshold level of the digital audio loss alarm.</p> <p>Audio Over [OFF] [CHAN 1+2] [CHAN 3+4] [ALL CHAN] Selecting relevant channels activates the audio over level alarm according to the parameters set on the following three pages.</p> <p>Set A Level [0dB] to [+20dB] in 1dB steps The threshold level of the analogue audio over alarm.</p> <p>Set D Level [-20dB] to [0dB] in 1dB steps The threshold level of the digital audio over alarm.</p> <p>Anti-Phase [OFF] [ALL CHAN] [CHAN 1+2] [CHAN 3+4] If there is sustained anti-phase between the selected channels of the audio feed, the alarm will be activated.</p> <p>Set Time 0.25, 0.5, 1, 3, 5, 10 seconds The time period before the Anti-Phase alarm is activated.</p>
ALARMS MENU		P3																							
SET D LEVEL	-20dB																								
AUDIO OVER	OFF																								
SET A LEVEL	-----																								
SET D LEVEL	-20dB																								
ANTI-PHASE	OFF																								
SET TIME	1 SEC																								
CARD 001	FRAME 001																								

Alarms Menu page 4	Description																								
<table border="1" style="width: 100%; border-collapse: collapse;"> <thead> <tr> <th colspan="2" style="background-color: #333; color: white;">ALARMS MENU</th> <th style="background-color: #333; color: white;">P4</th> </tr> </thead> <tbody> <tr> <td>ASSIGN ALM 1</td> <td>ANY</td> <td></td> </tr> <tr> <td>ASSIGN ALM 2</td> <td>DISABLED</td> <td></td> </tr> <tr> <td>ASSIGN ALM 3</td> <td>DISABLED</td> <td></td> </tr> <tr> <td>ASSIGN ALM 4</td> <td>DISABLED</td> <td></td> </tr> <tr> <td>ASSIGN ALM 5</td> <td>DISABLED</td> <td></td> </tr> <tr> <td>ASSIGN ALM 6</td> <td>DISABLED</td> <td></td> </tr> <tr> <td style="background-color: #333; color: white;">CARD 001</td> <td style="background-color: #333; color: white;">FRAME 001</td> <td></td> </tr> </tbody> </table> <p>Select alarms 1-6 with Function buttons. Scroll down to access further assignable alarms.</p> <p>Value buttons select alarm trigger.</p>	ALARMS MENU		P4	ASSIGN ALM 1	ANY		ASSIGN ALM 2	DISABLED		ASSIGN ALM 3	DISABLED		ASSIGN ALM 4	DISABLED		ASSIGN ALM 5	DISABLED		ASSIGN ALM 6	DISABLED		CARD 001	FRAME 001		<p>Assign Alarms 1 to 6 [ANY] [DISABLED] [SDI LOSS] [SDI FRZ] [PIC LOSS] [SYNC LOSS] [AES LOSS]>[AES1>AES2] [AUD LOSS]>[CHAN 1+2>CHAN 3+4>CHAN1>CHAN2 >CHAN3>CHAN4] [AUD OVER]>[CHAN 1+2>CHAN 3+4>CHAN1>CHAN2 >CHAN3>CHAN4] [PHASE]>[CHAN 1+2>CHAN 3+4] Alarm outputs may be assigned to specific alarm functions. There are 8 alarm outputs per card plus a frame master output, which comprises the sum of the individual outputs assigned. In the case of audio loss, audio over and phase, either all channels may be chosen or individual channels are shown on subsequent lines (shown linked by the > chevron symbol above). Some alarm functions may not apply depending on the card type fitted. When an individual card is selected, then inapplicable alarm functions will not appear. If ALL or FRM is selected, then inapplicable functions will be displayed but remain inoperative.</p>
ALARMS MENU		P4																							
ASSIGN ALM 1	ANY																								
ASSIGN ALM 2	DISABLED																								
ASSIGN ALM 3	DISABLED																								
ASSIGN ALM 4	DISABLED																								
ASSIGN ALM 5	DISABLED																								
ASSIGN ALM 6	DISABLED																								
CARD 001	FRAME 001																								

Alarms Menu page 5	Description																		
<table border="1" style="width: 100%; border-collapse: collapse;"> <thead> <tr> <th colspan="2" style="background-color: #333; color: white; text-align: center;">ALARMS MENU</th> <th style="background-color: #333; color: white; text-align: right;">P5</th> </tr> </thead> <tbody> <tr> <td style="width: 70%;">ASSIGN ALM 7</td> <td style="width: 25%;">DISABLED</td> <td></td> </tr> <tr> <td>ASSIGN ALM 8</td> <td>DISABLED</td> <td></td> </tr> <tr> <td>BUZZER</td> <td>OFF</td> <td></td> </tr> <tr> <td>FLASHING BAR</td> <td>ON</td> <td></td> </tr> <tr> <td colspan="2" style="background-color: #333; color: white;">CARD 001</td> <td style="background-color: #333; color: white;">FRAME 001</td> </tr> </tbody> </table> <p>Scroll down for further assignable alarms or functions.</p> <p>Value buttons select alarm trigger or function parameter.</p>	ALARMS MENU		P5	ASSIGN ALM 7	DISABLED		ASSIGN ALM 8	DISABLED		BUZZER	OFF		FLASHING BAR	ON		CARD 001		FRAME 001	<p>Assign Alarms 7 to 8 as for page 4</p> <p>Buzzer [ON] [OFF] Internal buzzer is set off during an alarm condition.</p> <p>Flashing Bar [ON] [OFF] Bargraph display flashes during an alarm condition.</p>
ALARMS MENU		P5																	
ASSIGN ALM 7	DISABLED																		
ASSIGN ALM 8	DISABLED																		
BUZZER	OFF																		
FLASHING BAR	ON																		
CARD 001		FRAME 001																	

Note: Unless alarm outputs are assigned, no alarms will be generated even if alarm functions have been configured.

Alarms status menu pages

Alarms Status Menu pages 1 & 2	Description																																				
<table border="1" style="width: 100%; border-collapse: collapse;"> <thead> <tr> <th colspan="2" style="background-color: #333; color: white; text-align: center;">ALARMS STATUS</th> <th style="background-color: #333; color: white; text-align: right;">P1</th> </tr> </thead> <tbody> <tr> <td style="width: 70%;">SDI LOSS</td> <td style="width: 25%;"></td> <td></td> </tr> <tr> <td>SDI FREEZE</td> <td></td> <td></td> </tr> <tr> <td>PICTURE LOSS</td> <td></td> <td></td> </tr> <tr> <td>SYNC LOSS</td> <td></td> <td></td> </tr> <tr> <td>AES LOSS</td> <td></td> <td></td> </tr> <tr> <td>AUDIO LOSS</td> <td></td> <td></td> </tr> <tr> <td colspan="2" style="background-color: #333; color: white;">CARD 001</td> <td style="background-color: #333; color: white;">FRAME 001</td> </tr> </tbody> </table> <table border="1" style="width: 100%; border-collapse: collapse;"> <thead> <tr> <th colspan="2" style="background-color: #333; color: white; text-align: center;">ALARMS STATUS</th> <th style="background-color: #333; color: white; text-align: right;">P2</th> </tr> </thead> <tbody> <tr> <td style="width: 70%;">AUDIO OVER</td> <td style="width: 25%;"></td> <td></td> </tr> <tr> <td>PHASE</td> <td></td> <td></td> </tr> <tr> <td colspan="2" style="background-color: #333; color: white;">CARD 001</td> <td style="background-color: #333; color: white;">FRAME 001</td> </tr> </tbody> </table> <p>Scroll down to view status of all alarms.</p>	ALARMS STATUS		P1	SDI LOSS			SDI FREEZE			PICTURE LOSS			SYNC LOSS			AES LOSS			AUDIO LOSS			CARD 001		FRAME 001	ALARMS STATUS		P2	AUDIO OVER			PHASE			CARD 001		FRAME 001	<p>Provides details of alarms present and which channels they affect.</p> <p>[CHAN 1+2] [CHAN 3+4] [ALL CHAN]</p> <p>A triggered alarm can be reset by scrolling to the alarm and pressing both Value buttons simultaneously.</p>
ALARMS STATUS		P1																																			
SDI LOSS																																					
SDI FREEZE																																					
PICTURE LOSS																																					
SYNC LOSS																																					
AES LOSS																																					
AUDIO LOSS																																					
CARD 001		FRAME 001																																			
ALARMS STATUS		P2																																			
AUDIO OVER																																					
PHASE																																					
CARD 001		FRAME 001																																			

Note: Use the card select buttons in the Alarms Status pages to view the alarm status of other cards and frames.

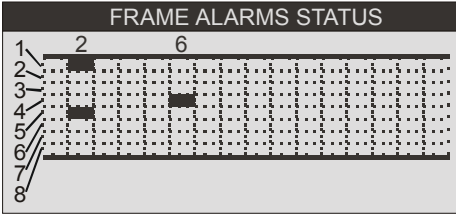
Frame Alarms Display	Description
	<p>In an alarm condition, the Frame Alarms Status page of the LCD opens automatically on the relevant frame.</p> <p>This is a graphic representing all 16 cards in the frame and a flashing indicator against the alarm assignment (1 to 8) that has been triggered. The rows on the Frame Alarms Status graphic correspond from top to bottom with assigned alarms 1 to 8. The row numbers in the illustration are not shown on the LCD.</p>

Colours menu pages

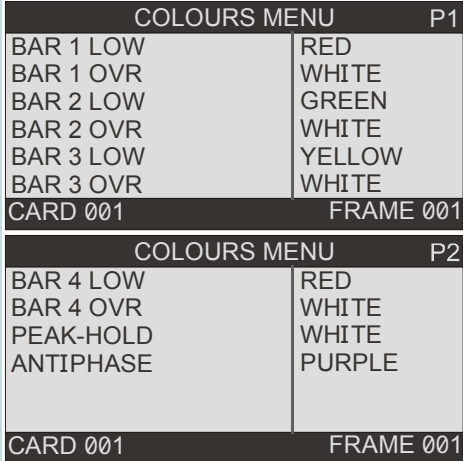
Colours Menu pages 1 & 2	Description
 <p>Scroll down to select all colours.</p>	<p>Selects the colours for the over level and lower sections of bargraphs 1, 2, 3 and 4, the peak-hold cursor and the anti-phase indicator.</p> <p>[RED] [ORANGE] [YELLOW] [WHITE] [PURPLE] [GREEN] [BLUE] [CYAN]</p>

Note: Default colours are shown in the Colours Menu pages above.

Bargraph Variations

The bargraphs may be displayed as full, half or quarter sizes.

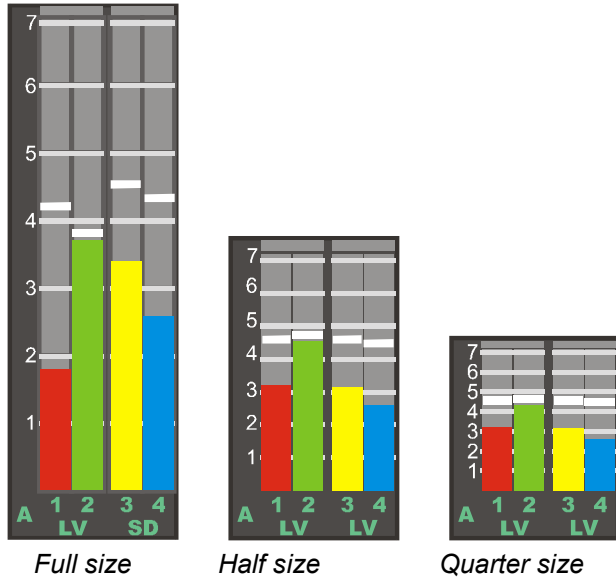

The following scales and ballistics may be selected for the bargraphs.

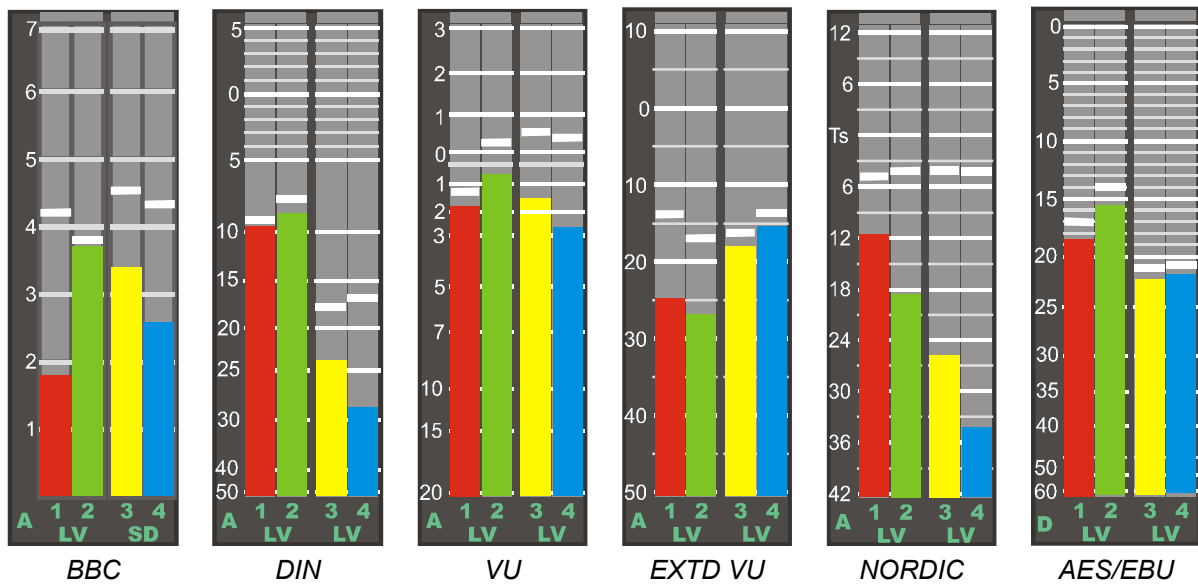

Note: The AES/EBU scale is only available with digital audio inputs.

Installation

The Chromatec E-Series 3U frame may be installed in 19 inch bays with 355mm depth. Ventilation is produced in each frame with two fans at the left side (viewed from front) with the exhaust at the right rear. Frames may be installed into bays without vertical separation, providing airflow through these apertures is not impeded.

The frame includes cable harness tie bars at the rear to relieve strain on data and I/O connectors. It is not recommended that these cable harness bars are removed, unless other means of relieving strain on cables and connectors is provided.

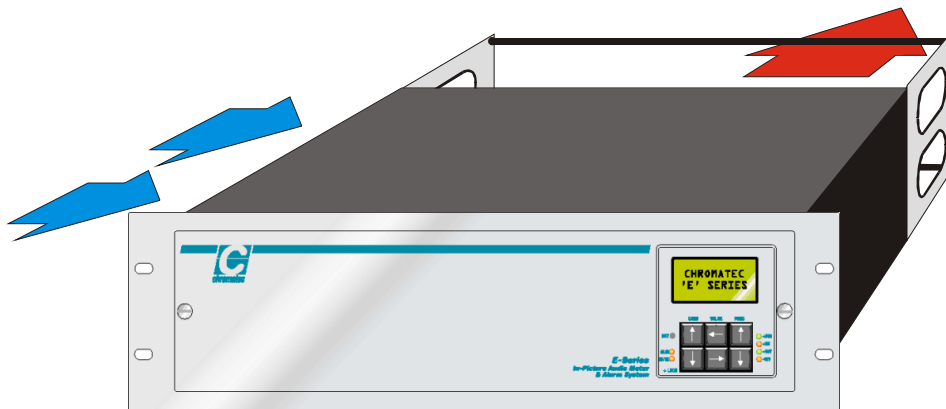

The 3U E-Series frame showing ventilation

Fitting Chromatec E-Series cards

The front panel may be removed by unscrewing the two retaining screws. E-Series Eurocards may then be fitted into (or removed from) the card guides provided. Gently push the cards into the motherboard sockets taking care that cards fit into both upper and lower guides. It is recommended that power be removed before inserting or removing cards.

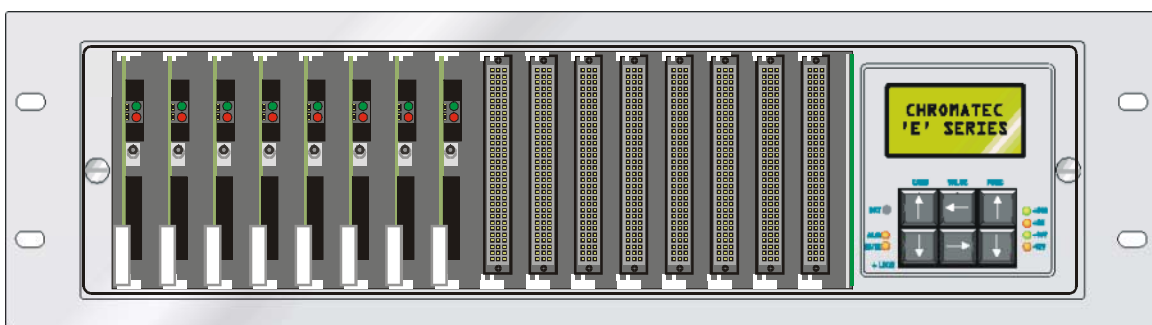

The 3U E-Series frame showing cards and free card slots

Identifying cards

There are four types of E-Series cards available which may easily be recognised from the serial number information printed on the back or the model number silk screened on the card.

Part number	Description
SD4-EA	SDI video in, analogue or embedded audio in, serial number prefix SDA
SD4-ED	SDI video in, AES or embedded audio in, serial number prefix SDD
AM4-EA	Composite video in, analogue audio in, serial number prefix AB
AM4-ED	Composite video in, AES audio in, serial number prefix DB

Choosing the video output

The SD4-EA and SD4-ED SDI cards include decoder circuitry to allow PAL or SDI outputs. Select the video output format with the jumper provided as shown in the following diagram:

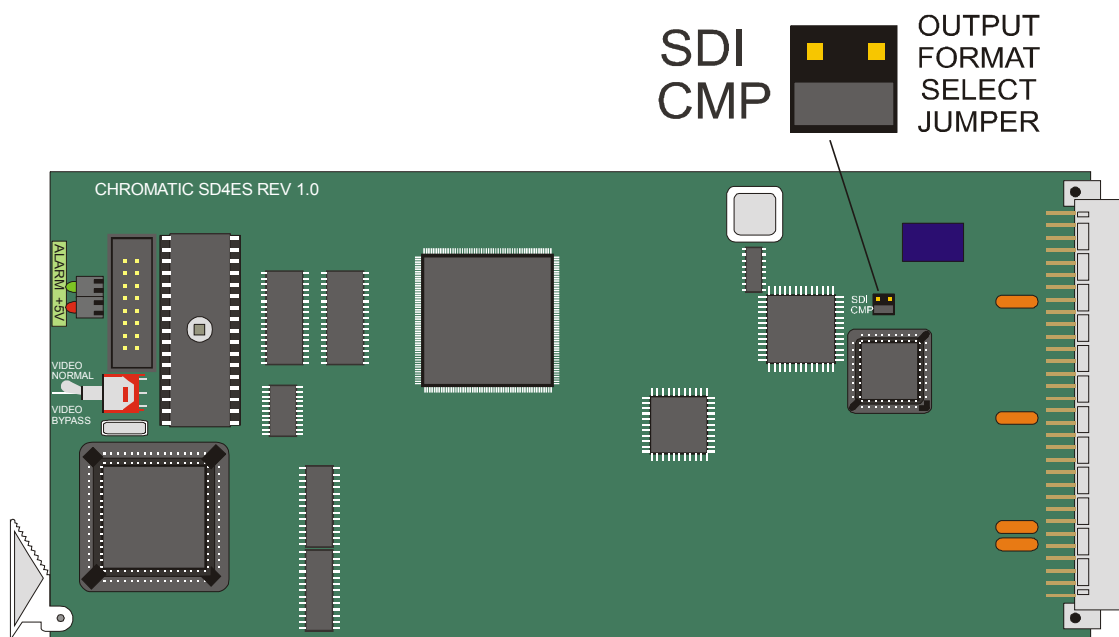

Selecting the output format on SDI input cards

Note: Remove power before removing cards. Only restore power after cards have been fully inserted.

Linking frames

Several frames may be linked via the Link-In and Link-Out ports to enable any size of system. Any one of the frame control modules that are linked may be used to alter settings and carry out alarm resets on the entire system. Linking is accomplished with simple 9-way 'D' connector extension cables. These can be wired pin-to-pin (1 to 1, 2 to 2 etc.) and preferably with an overall screen connected to one of the GND connections (see pinout information in the Connector I/O chapter).

The following diagram illustrates the principle of linked frames:

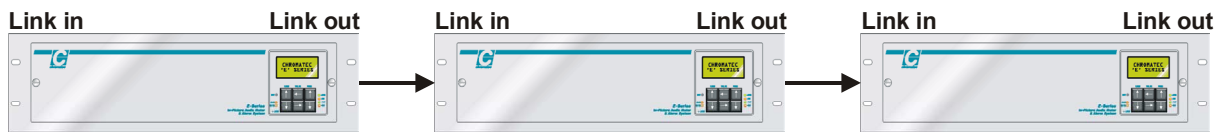

Linking E-Series frames to create larger systems

CAUTION: Only connect Data-Out ports to Data-In ports. Do not connect Data-In ports together!

Selecting the frame address

In linked or expanded systems each frame must have a unique address. Enter the main menu as described in the Operating chapter and scroll to the end of the available functions. The UNIT ADDRESS function is at the end of the Main Menu. A consecutive number starting from 0 (zero) to 31 may be chosen for each frame in the system.

Main Menu page 4	Description																		
<table border="1"> <thead> <tr> <th colspan="2">MAIN MENU</th> <th>P4</th> </tr> </thead> <tbody> <tr> <td>INTERNAL VID</td> <td>PAL</td> <td></td> </tr> <tr> <td>NTSC PED</td> <td>ON</td> <td></td> </tr> <tr> <td>SET DEFAULTS</td> <td></td> <td></td> </tr> <tr> <td>UNIT ADDRESS</td> <td>1</td> <td></td> </tr> <tr> <td>CARD 001</td> <td>FRAME 001</td> <td></td> </tr> </tbody> </table>	MAIN MENU		P4	INTERNAL VID	PAL		NTSC PED	ON		SET DEFAULTS			UNIT ADDRESS	1		CARD 001	FRAME 001		<p>Unit Address [0] to [31] Assigns an address to the frame. The address must be unique to avoid conflicts on the serial bus.</p>
MAIN MENU		P4																	
INTERNAL VID	PAL																		
NTSC PED	ON																		
SET DEFAULTS																			
UNIT ADDRESS	1																		
CARD 001	FRAME 001																		

Health and safety considerations

The Installation and Maintenance of the Chromatec E-Series In-Picture Audio Meter and Alarm System (hereafter referred to as the E-Series) and any associated equipment, must be carried out by PERSONS SUITABLY QUALIFIED to work with equipment which may be connected to the mains supply.

The E-Series MUST BE DISCONNECTED & ISOLATED FROM THE MAINS INPUT and from other product outputs before undertaking maintenance.

ELECTRIC SHOCK HAZARDS exist if conductive instruments, neck chains or fingers etc are placed within the E-Series or in close proximity of the input/output terminals/connectors.

Incorrect installation can cause internal components to rupture and particles to be ejected from the product.

TOXIC FUME HAZARDS exist if the E-Series is subjected to direct flames or excessive temperature of above 100 Degrees Centigrade ambient.

The mounting and installation of the E-Series must be arranged by the user to comply with all safety regulations by the indigenous authority.

Disposal

Do not incinerate as explosive and toxic fume hazards exist. Disposal must be by dismantling the product to component level and disposing of each component by an approved method.

Connector I/O

All connections are provided on the rear panel of the frame. Audio and alarm connections use high-density 15 way 'D' type connectors. Video inputs and outputs use BNC connectors and all data connectors use 9 way 'D' type connectors.

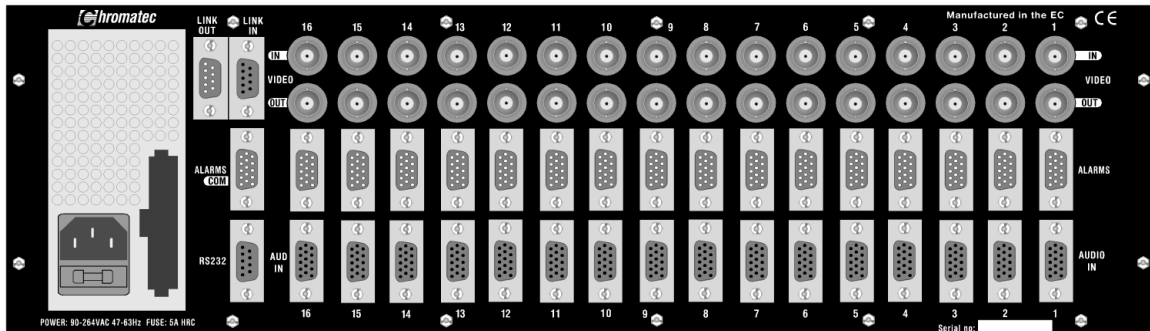

E-Series 3U frame connector I/O

Audio input connector pinout

Connector type: 15 way sub-D female high density (3 rows by 5 pins)

Pin	Digital audio	Analogue audio
1		Analogue Audio In 1 Right Pos.
2	Digital Audio In 1 A	Analogue Audio In 1 Left Pos.
3		Analogue Audio In 2 Right Pos.
4	Digital Audio In 2 A	Analogue Audio In 2 Left Pos.
5	GND	GND
6	GND	GND
7	GND	GND
8	GND	GND
9	GND	GND
10	GND	GND
11		Analogue Audio In 1 Right Neg.
12	Digital Audio In 1 B	Analogue Audio In 1 Left Neg.
13		Analogue Audio In 2 Right Neg.
14	Digital Audio In 2 B	Analogue Audio In 2 Left Neg.
15	GND	GND

Alarms connector pinout

Connector type: 15 way sub-D male high density (3 rows by 5 pins)

Pin	Description
1	ALARM1
2	ALARM3
3	ALARM5
4	ALARM7
5	-DISALARM
6	GND
7	GND
8	GND
9	GND
10	GND
11	ALARM2
12	ALARM4
13	ALARM6
14	ALARM8
15	-EXTRESET

RS422 Link in/out connectors pinout

Link in connector type: 9 poles D female

Link out connector type: 9 poles D male

Speed: 57600 bps

Format: 8 bit, no parity, 1 stop

Pin	Description
1	+5V (on link in only)
2	Not connected
3	Rx/Tx -
4	GND
5	GND
6	+5V (on link in only)
7	Not connected
8	Rx/Tx +
9	GND

RS232 Host interface connector pinout

Connector type: 9 way D male

Speed: 57600 bps

Format: 8 bit, no parity, 1 stop

Pin	Description
1	Not connected
2	Tx (to host)
3	Rx (from host)
4	Not connected
5	GND
6	Not connected
7	Host transmit enable (active low, RTS)
8	Not connected
9	Not connected

Problem solving

There are LED indicators on the front edge of each card that show if an alarm condition exists on that card and if the +5V power rail is present. LED indicators adjacent to the button cluster on the front panel monitor individual power rails from the integral power supply.

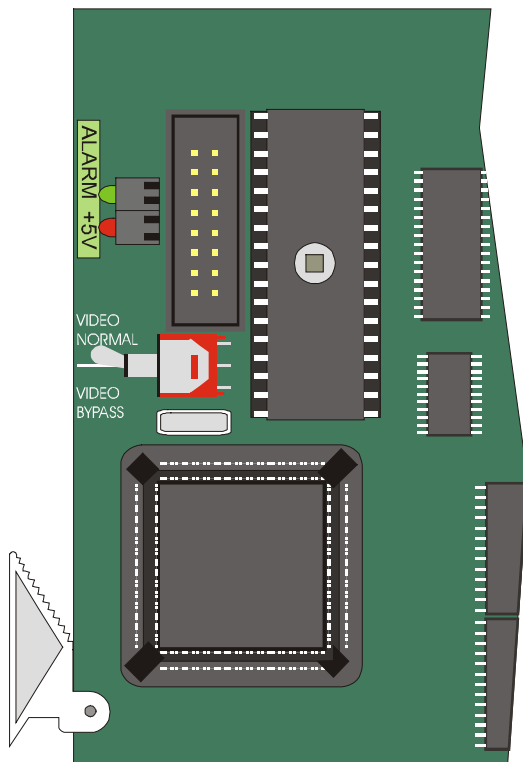

Card edge LEDs and controls



Frame LEDs and controls

A miniature toggle switch at the card edge allows the video input to be switched directly to the output. This may be useful in an emergency situation, in the unlikely event of a problem with the card. It may also be used to remove the bargraph from the display without disabling the card's alarm outputs. However, any Composite output on SDI cards will not then be in use.

The bypass function can also be set from Main Menu page 3. The bargraph display can also be turned off by setting both bargroup A and B to OFF in Main Menu page 1. This will preserve the Composite output on SDI cards.

Note: In the unlikely event that a card 'locks up' or if settings have been changed to obscure values, use the Set Defaults function in Main Menu page 4 for that card.

Sample problems and their solutions

The LCD display is too bright or too dim

Adjust the LCD contrast with a small flat bladed screwdriver in the BRT (brightness) control adjacent to the LCD display

There is no power to the rack or cards

Check the power cabling and the integral fuse in the IEC mains socket at the rear of the frame

The +5V LED is out on one card only and the card does not function

Remove the power to the rack and try re-seating the card, then restore the power. If this is unsuccessful, contact Customer Support at Michael Stevens & Partners Ltd.

The bargraph display does not appear on one or more cards

Check that the bypass switch is not in the bypass position

Check that the Bypass function is not set in Main Menu page 3

Check that an appropriate Bargroup has been selected in Main Menu page 1

There is no video background on one or more card outputs

Check that a video input is present on the cards affected and that it is appropriate for the card

Alarms have been configured but alarm outputs fail to be generated

Check that appropriate alarms have been assigned to one or more alarm outputs in Alarms Menu pages 4 and 5

The Phase display has been enabled but does not appear on stereo signals

The Phase display only appears if stereo signals are out of phase by more than $\pm 90^\circ$

One or more card settings have become completely misadjusted

Use the Set Defaults function in Main Menu 4 for the card or cards affected

Specification

Model SD4-ED

Video input	SMPTE 259M Serial Video with SMPTE 272M embedded audio. Auto equalisation with cable length from 10m to 100m.
Audio input	Two pairs of AES/EBU on mini 15 pin Hi-density 'D' connector OR 1 group of embedded audio from SDI input.
Video output	SMPTE 259M Serial Video OR PAL/NTSC composite video

Model SD4-EA

Video input	SMPTE 259M Serial Video with SMPTE 272M embedded audio. Auto equalisation with cable length from 10m to 100m.
Audio input	Four analogue balanced channels on mini 15 pin Hi-density 'D' connector OR 1 group of embedded audio from SDI input.
Video output	SMPTE 259M Serial Video OR PAL/NTSC composite video

Model AM4-ED

Video input	PAL or NTSC composite video
Audio input	Two pairs of AES/EBU on mini 15 pin Hi-density 'D' connector OR 1 group of embedded audio from SDI input.
Video output	PAL/NTSC composite video on BNC connector

Model AM4-EA

Video input	PAL or NTSC composite video
Audio input	Four analogue balanced channels on mini 15 pin Hi-density 'D' connector OR 1 group of embedded audio from SDI input.
Video output	PAL/NTSC composite video on BNC connector

Analogue scale BBC, DIN, VU, EXT D VU and NORDIC

Digital scale BBC, DIN, VU, EXT D VU, NORDIC and AES/EBU

Alarms

Carrier alarms	SDI carrier loss AES/EBU carrier loss
Video alarms	Picture loss, SDI loss, SDI freeze, Sync loss (Picture loss only available with SDI inputs)
Audio alarms	AES loss (any chan, chan 1&2, 3&4, chan 1,2,3 or 4) Audio loss (any chan, chan 1&2, 3&4, chan 1,2,3 or 4) Audio over (any chan, chan 1&2, 3&4, chan 1,2,3 or 4) Audio phase (any pair, chan 1&2, 3&4)

Housing

19" Rack Mount: 3U high.
Outline Dimensions: 484mm(W) x 355mm(D) x 134mm(H)
Depth includes cable tie bars.

Power

90-264 VAC 47-63Hz Fuse 3.15A HAC
IEC mains socket and low-voltage power connector for optional external auxiliary power supply (Chromatec model E-PSU).

Environmental

Operating Temperature: 0-50 Degrees C (derate @ 2.5%/ Degree C to 70 Degrees C)
Humidity: 70% max

Front panel

6 configuration buttons, LCD display, warning and power LEDs

Rear panel

Video I/O BNC connectors, Hi-Density 15 way 'D' audio connectors, 9 way 'D' alarm connectors

Frame Link

9 way 'D' female (IN) and 9 way 'D' male (OUT) connectors

Computer interface

9 pin RS-232 male PC-AT serial interface